

**BB3002 EVA SPECIFICATIONS:**

**COVER SIZE**

MAX 710 mm x 395 mm (28" x 15.6")  
MIN 200 mm x 100 mm (8" x 4")

**COVER WEIGHT**

80-300 gsm  
20 lb Bond – 110 lb Index

**TEMPERATURE**

MAX GLUING TEMPERATURE 180° (356° F)  
MIN GLUING TEMPERATURE 115° (239° F)  
SENSITIVITY ± 2° (4° F)

**BBR STACKING CAPACITY**

680 MM – 26.4"  
RECEPTION SIZE  
MAX 385 mm x 320 mm (15.15" x 12.6")  
MIN 100 mm x 100 mm (3.9" X 3.9")

**CYCLES / HR**

Up to 500

**NOISE LEVEL**

76dB (A) at operator position

**ELECTRICAL RATINGS**

Power required  
- 208/220 V, 60Hz,  
3 phases delta, 12 A  
- 220/230 or 240 V, 50 Hz,  
3 phases delta 12A  
- 380/400 or 415 V, 50 Hz, 3 phases  
star, no neutral needed, 12 A

Power consumption 4 Kw

**RADIANT HEAT**

13648 BTU/h

**DIMENSIONS:**

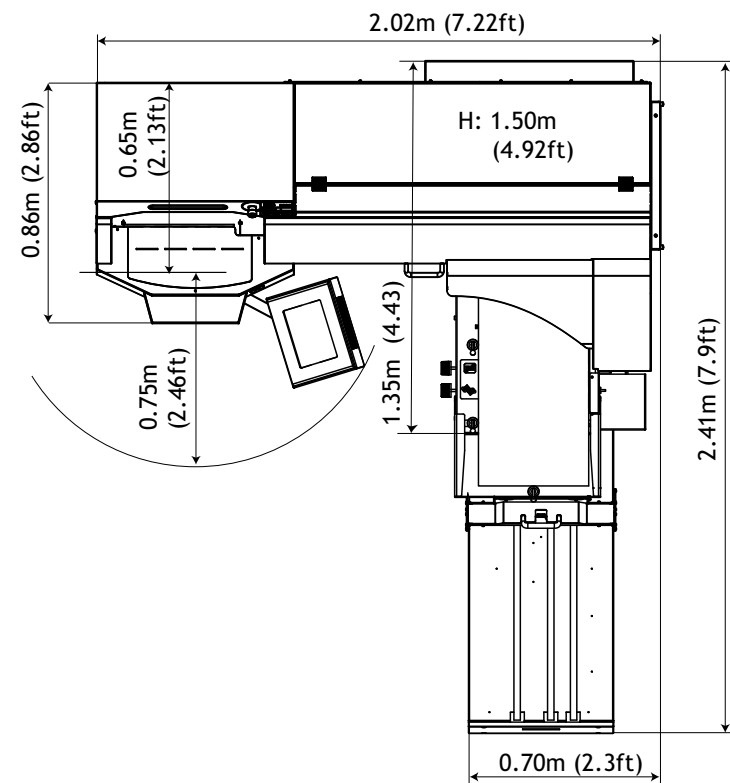

**PERFECT BINDING MODE:**

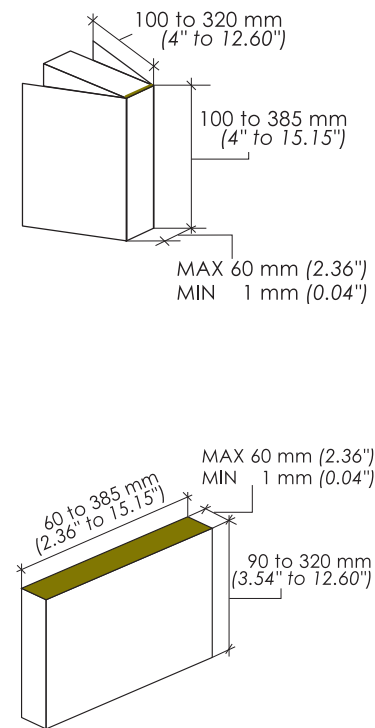

Production rates subject to environmental conditions, operator ability and quality of stock.  
As a consequence of our policy of continuous improvement, specifications are subject to change without notice.

9133606 Ind. May 2008

**BELGIUM**

C.P. Bourg S.A. N.V.  
Group European Headquarters  
22, rue des Technologies  
B-1340 Ottignies  
Belgium  
Tel.: +32 10 62 22 11  
Fax: +32 10 61 36 38  
Export fax: +32 10 61 63 55  
E-mail: [contactus@cpbourg.com](mailto:contactus@cpbourg.com)  
[export.be@cpbourg.com](mailto:export.be@cpbourg.com)

**FRANCE**

C.P. Bourg S.A.  
Parc d'Affaires Silic  
32, rue des Gémeaux  
BP 60410  
F-94573 Rungis  
France  
Tel.: +33 1 46 87 32 14  
Fax: +33 1 46 87 52 17  
E-mail: [cpbourg\\_france@cpbourg.com](mailto:cpbourg_france@cpbourg.com)

**USA**

C.P. Bourg Inc  
USA Headquarters  
50 Samuel Barnet Blvd.  
New Bedford, MA 02745  
USA  
Tel.: +1 508 998 2171  
Fax: +1 508 998 2391  
E-mail: [cpbourgusa@cpbourg.com](mailto:cpbourgusa@cpbourg.com)

**GERMANY**

C.P. Bourg GmbH  
Schweizerstrasse 70/1  
D-72336 Balingen  
Germany  
Tel.: +49 7433 9981 680  
Fax: +49 7433 9981 686  
E-mail: [cpbourg\\_germany@cpbourg.com](mailto:cpbourg_germany@cpbourg.com)

**LUXEMBOURG**

Ets C.P. Bourg Luxembourg S.A.  
14 rue Millewee, B.P. 85  
L-7201 Walferdange  
Luxembourg  
Tel.: +352 33 24 47  
Fax: +352 33 19 99  
E-mail: [cpbourgluxembourg@cpbourg.com](mailto:cpbourgluxembourg@cpbourg.com)

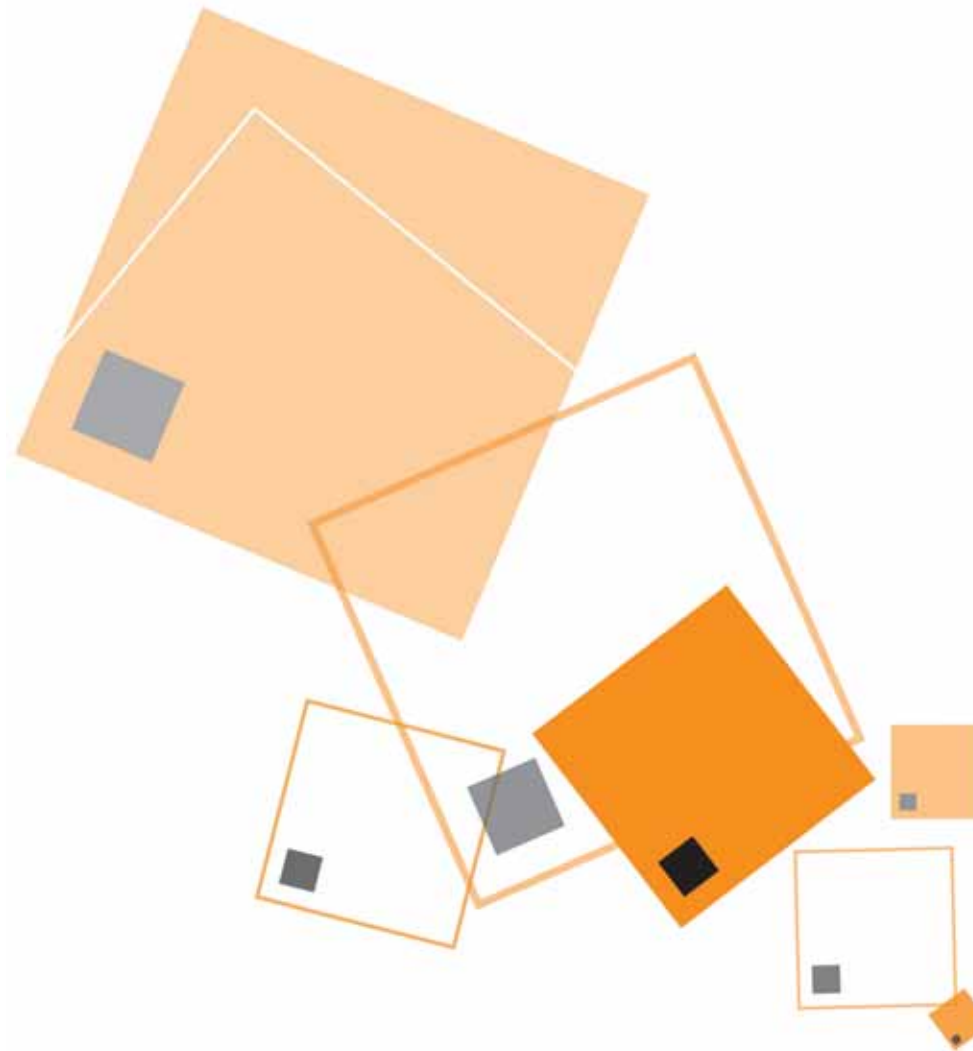

# THE BOURG BB3002 FULLY AUTOMATIC PERFECT BINDER HAS EVA OR PUR GLUING OPTIONS.

The first automatic self setting binder, you insert the book and the machine self adjusts to the book thickness and length, even for book for one.

- Fitment with EVA glue tank for binding regular paper stocks.
- Two application rollers and a reverse rotating scraper roller for perfect glue application.
- Full side contact (not low quality tangential contact) side gluing rollers for better side gluing application.
- Space saving design with extra small footprint.
- Delivered as standard with fully automatic book stacker cooler.
- Bind books up to 60 mm, milling to 3 mm.
- Jogger unit built-in.
- Easy to use, self explanatory full color user interface, no set up required ever.
- Padding mode.
- Maximum production speed ca 350 books per hr.
- Easy accessibility and total process visibility.

The only binder in the world with an integrated cover creasing unit for providing multiple creases in digitally printed covers (not a low quality scoring system that damages the print surface and cracks the covers).



# BB3002 PUR (POLYURETHANE REACTIVE)

## BB3002 WITH VERTICAL BOOK STACKER AND NORDSON PUR APPLICATION SYSTEM PICTURED



Full color touch screen interface



- 99 job memories.
- Self calculating process.

3 rollers EVA tank

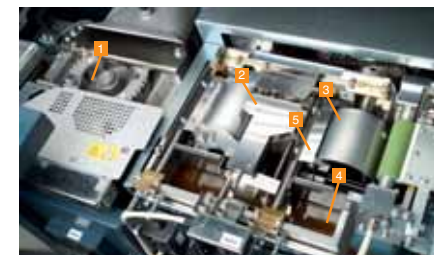

- Automatic milling control with integrated spine shredders for maximum glue penetration.
- Self adjusting full contact side gluing unique to Bourg.
- Double application and scraper roller.
- Automatic glue level control.
- Self adjusting glue cut-off.

Full suction cover feeder

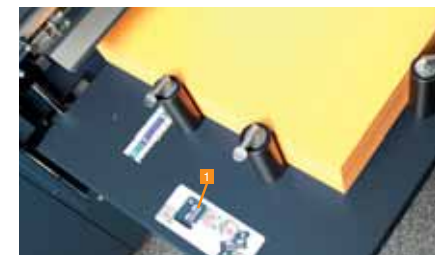

- Margin and squariness adjusting.
- Full contact cover feed with double and miss detection. 80 mm capacity.

Fully automatic cover creaser

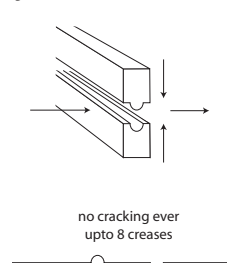

Book cross-section

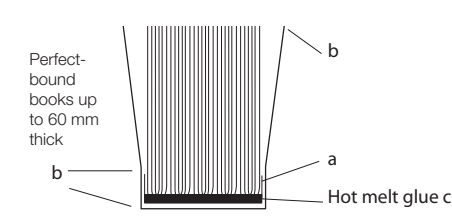

Winged books

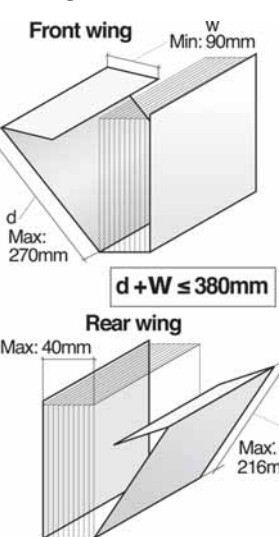

- Automatic nipper control unique to Bourg.
- Unique cover creasing unit provides multiple up to 13 male or female creases to your covers.
- Fully automatic vertical book stacker unique to Bourg.
- Integrated fumes suppressor unique to Bourg.
- High power double vortex dust recovery unique to Bourg.

## PUR nozzle system advantages

- No glue tank cleaning needed or tank extraction required, ever.
- Nozzle application for binding difficult paper stocks.
- Precise application, width and length.
- Reduced glue usage per book, spend less money on glue.
- No glue wastage at the end of the day.
- Reduced fume emissions.

## Why use PUR glue

- Book spine is more flexible, books tend to lay flat better.
- Better glue adherence (sheet pull test resistance + 50 pct typically).
- Better application to digitally printed silicone coated sheets.
- Will not remelt once set (good for books used in high temperature environments).
- Less energy used in the gluing process (good for the ecology).